

ILBAGNOALESSI

Wall-hung WC 'rimless', washdown, without flushing rim



DIMENSIONS

Length	585 mm
Width	390 mm
Height	355 mm

COLOUR AND FINISH

<input type="checkbox"/>	400 White LCC (LAUFEN Clean Coat)
--------------------------	-----------------------------------

OPTIONS

000 - standard option

SPECIFICATION TEXT

Wall-hung WC rimless washdown Laufen-ILBAGNOALESSI, sanitary ceramic for concealed cistern, EN 997, EN 33, min. 5/3-l-flush, dimensions 390 x 585 x 400 mm, concealed trap, concealed fixation.

Special feature: Surface refinement LCC (only white), rimless, concealed surfaces directing water are fully glazed throughout, vacuum checked.

Further options / accessories: WC seat and cover with automatic lowering H892971

MOUNTING ACCESSORIES INCLUDED

Laufen EasyFit 2.0 system M12, order no. H893828

MOUNTING ACCESSORIES EXCLUDED

Antinoise set, order no. H892695

Stone screw fixing set M12

Average water consumption (L.) : 3.38

Fixing kit : New EasyFit 2.0 included

Flushing system : Washdown

Height (INCH) : 14"

Installation type : Wall-hung

Length (INCH) : 23 1/16"

Net weight (kg) : 23

Outlet type : Horizontal

Rim type : Rimless

Shape : Round

Style : Opulent

Water Inlet System : Back Inlet

Width (INCH) : 15 3/8"

TECHNICAL DRAWINGS

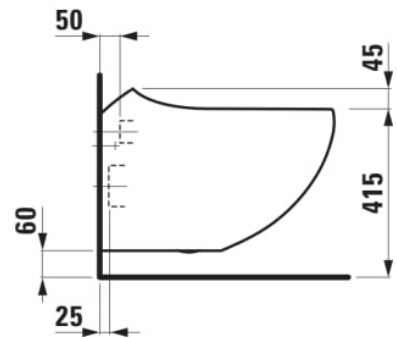
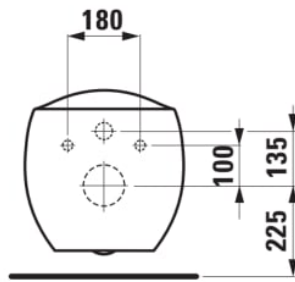
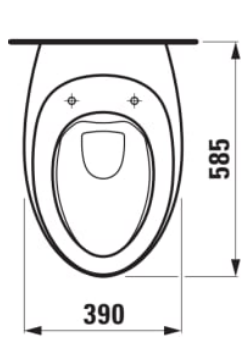

COMPATIBLE WITH



WC seat and cover, removable, with lowering system

H892971...0001



Ceramic toilet roll holder

H870970...0001



Ceramic toilet roll holder

H870970...8991



INEOLINK slim (90 mm) concealed cistern for wall-hung WC and shower WC

H9201100000001



INEOLINK concealed cistern for wall-hung WC

H9201140000001



INEOLINK concealed cistern for wall-hung WC and shower WC

H9201150000001



Installation set for wall-hung WCs and bidets, EasyFit 2.0, 250 mm

H8938280000001

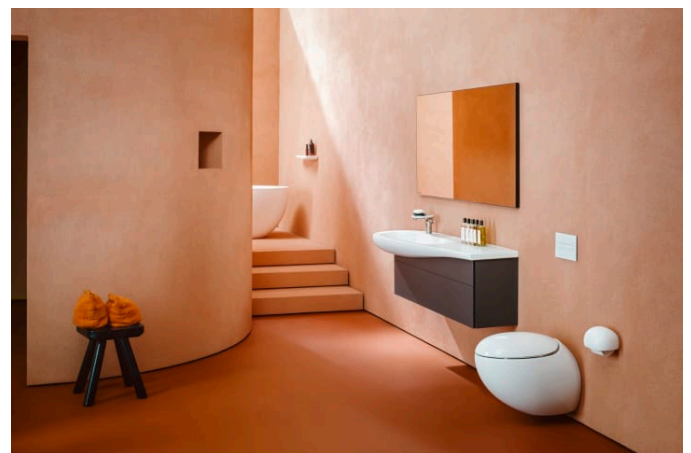
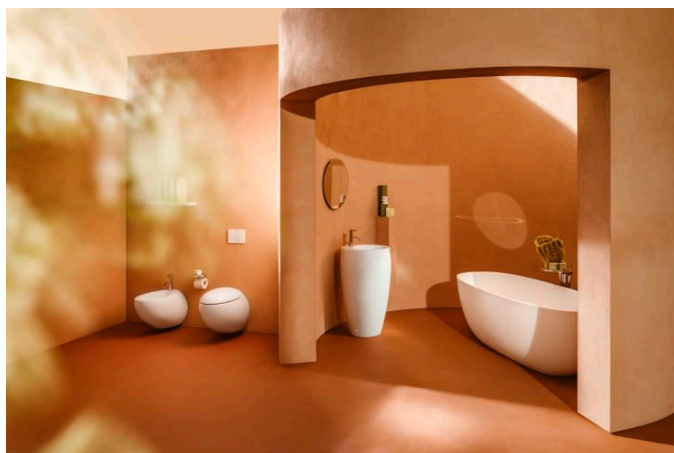



ILBAGNOALESSI

ILBAGNOALESSI is a bathroom design that has cast its spell over the home design world for years: It is characterised by a timeless form, sparkling imagination and a hint of eccentricity. This design award-winning ensemble is the creation of Italian designer star, Stefano Giovannoni.

